



UNIVERSITAT POLITÈCNICA
DE CATALUNYA
BARCELONATECH

BioMetallum

9 febrer 2023





Grup de recerca

BIOGAP - Grup de Tractament Biològic de Contaminants

SSR-UPC - Smart Sustainable Resources

RIIS - Grup de Recerca en Recursos i Indústries Intel·ligents i Sostenibles

Departament

Departament d'Enginyeria Minera, Industrial i TIC

Centre docent

Escola Politècnica Superior d'Enginyeria de Manresa





HISTÒRIC BIOPROCESSOS



LLAVOR+PRODUCTE: Optimization & Validation of a Bio-based Prototype for valuable metals recovery from electronic wastes

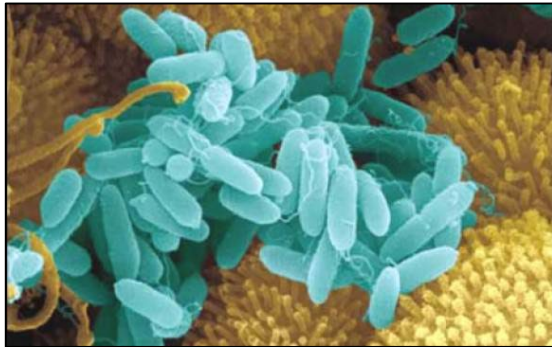
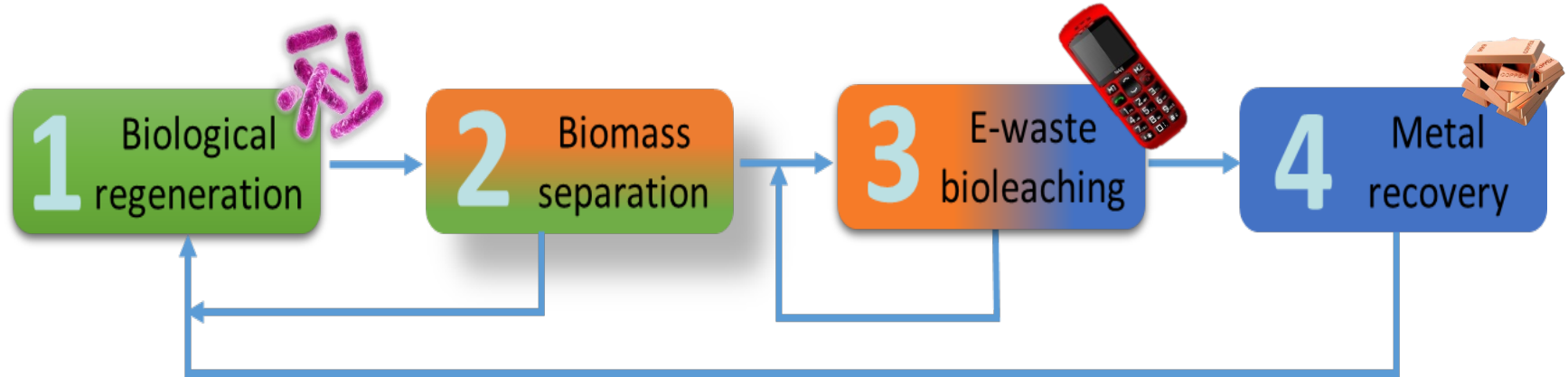

PATENT
P201830406

WO2019206755A1
PCTES2021070069

BIOMETAL (RETOS 2021-2024)

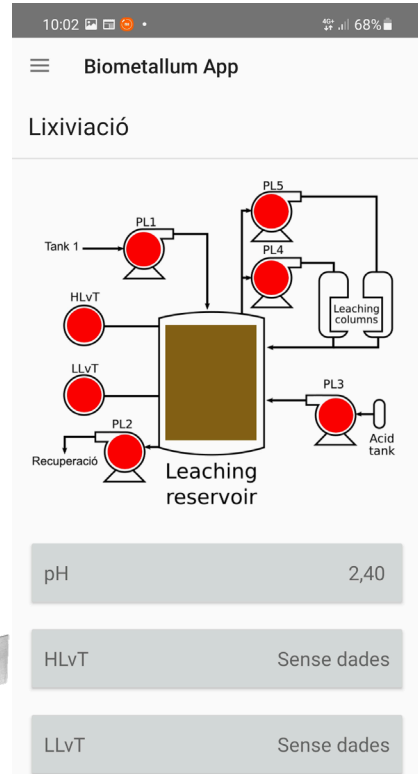
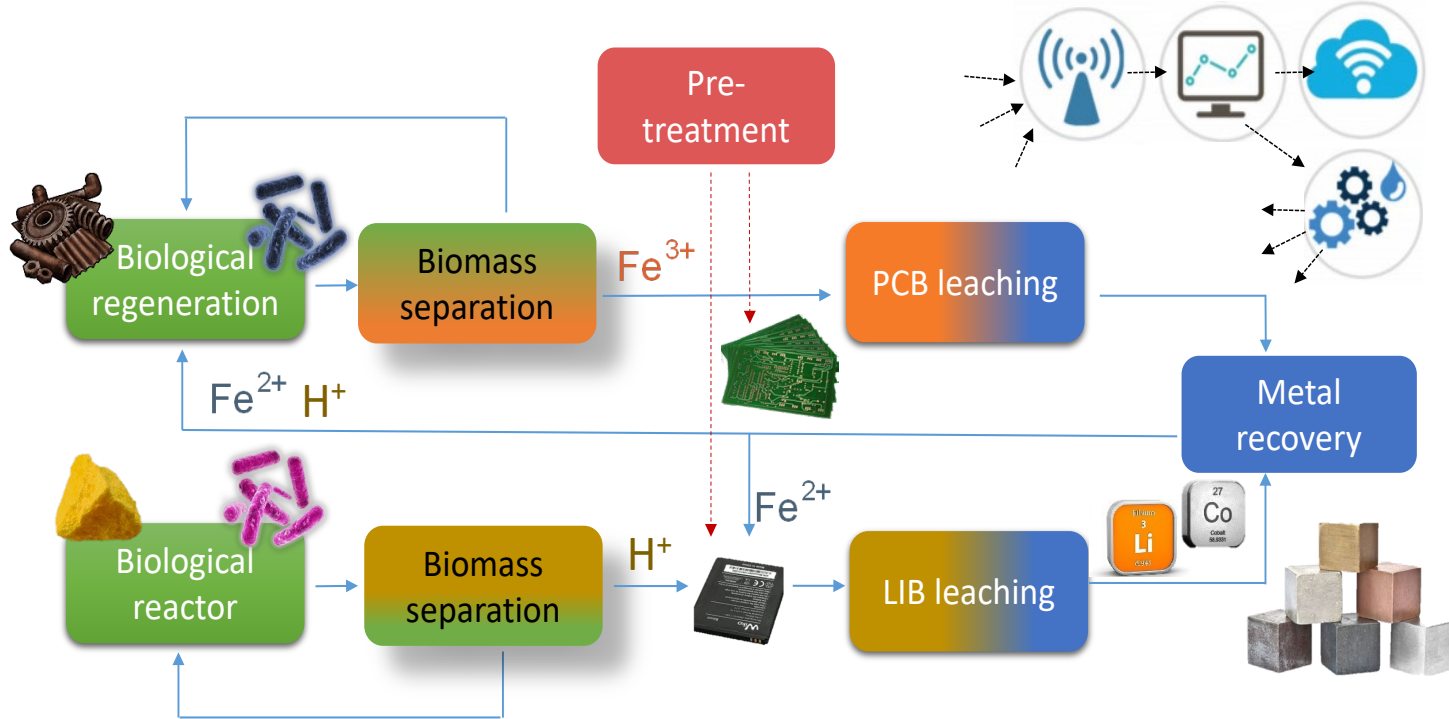

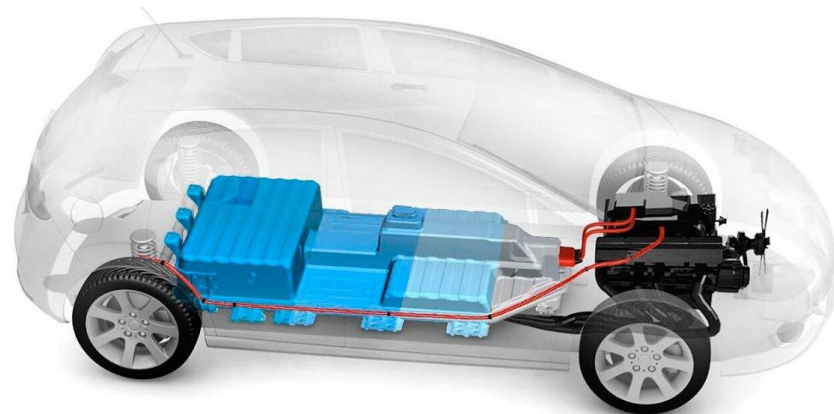

SEAT S.A.



Dpto. Ingeniería Química

- Bioprocesos para el tratamiento de sulfuros minerales y concentrados
- Tratamiento de residuos y efluentes mineros e industriales
- Tratamiento de residuos urbanos
- Control del Fresado Químico del Aluminio y Tratamiento del Efluente
- Biolixiviación de Sulfuros Metálicos
- Tratamiento de Cenizas de Pirita
- Tratamiento de Escorias de Fundición de Cobre
- Tratamiento de los Polvos de Acería
- Biolixiviación de Concentrados Globales y Depuración de Efluentes de Instalaciones





XARXA TEMÀTICA BIOPROMET



UNIVERSITAT POLITÈCNICA DE CATALUNYA



Universidad de
Castilla-La Mancha



Universidad
de Cádiz

eman la zabal zazu



UPV EHU



UAB

Universitat Autònoma
de Barcelona

eurecat
Technology Centre of Catalonia

BIOPROMET



GOBIERNO
DE ESPAÑA

MINISTERIO
DE CIENCIA
E INNOVACIÓN



Cobre Las Cruces, S.A.



RECUPERACIONS NAVARRO MARCEL NAVARRO I FILLS, S.L.



AMB Àrea Metropolitana de Barcelona



Oliva Torras MOUNT & DRIVE KITS



Ajuntament de Manresa

FAIRPHONE



CONSELL COMARCAL DEL BAGES



UAB



Waste Resources Innovation



grup asproseat

Lila Lila Serveis ambientals



Diputació Barcelona



CONSORCI DEL BAGES PER A LA GESTIÓ DE RESIDUS

prat & reciclatge



ACS RECYCLING Electrònics de Catalunya, s.l

SOLIDANÇA Economia Social i Solidària CIF: G-61201894

SEAT S.A.



Agència de Residus de Catalunya



electrorecycling

aeris TECNOLOGÍAS AMBIENTALES

eurecat Centre Tecnològic de Catalunya



CELSA GROUP



PONTIFICIA UNIVERSIDAD CATOLICA DE VALPARAISO

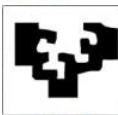

UNIVERSIDAD DEL PAÍS VASCO - EUSKAL HERRIKO UNIBERTSITATEA



TECHNISCHE UNIVERSITÄT BERGAKADEMIE FREIBERG

Die Ressourcenuniversität. Seit 1765.

TACTOTEK

REVIVACK





EQUIP MULTIDISCIPLINAR



Enginyeria
química

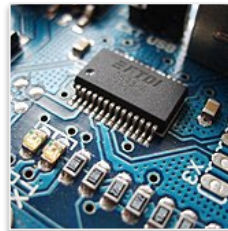

Enginyeria
electrònica

Biotecnologia



Química



Informàtica

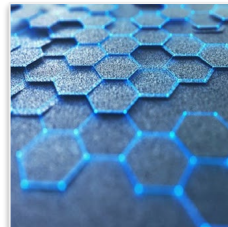

Enginyeria
minera



Xavier Gamisans



Concepció Lao



Montserrat Solé



F. X. de las Heras



Lluís Sanmiquel



Teresa Escobet



Hernan Anticoi



Francisco Carranza
Alfonso Mazuelos
Nieves Iglesias
Pablo Ramirez
Martín Moreno
Blanca Perdigones
Aurora Romero
Rafael Romero



Anna Bonsfills



Ana María Cano

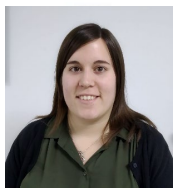

Eva Benzal



Xesca Sala



Marta Tarrés



Toni Escobet



Marc Bacompta

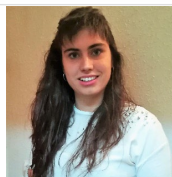

Lidia Orriols



Xavier Guimerà



Eloi Morral

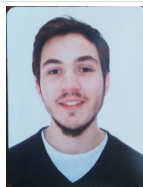

Ramon Miquel



Lidia García

Antonio David Dorado, PhD



toni.dorado@upc.edu



www.biometallum.com



@toni_dorado

