



R&D IN INDUSTRY 4.0 AT THE UPC

2023



UNIVERSITAT POLITÈCNICA
DE CATALUNYA
BARCELONATECH

CONTENT

01

THE UPC

Get to know the Polytechnic University of Catalonia (UPC) and discover some of its indicators.

02

INDUSTRY 4.0

What is meant by Industry 4.0?

03

RESEARCH AND INNOVATION

Description of the research groups, centers and institutes that generate knowledge in the field of Industry 4.0.

04

UPC EXCELLENCE PROJECTS

Selection of R&D projects with the greatest impact on Industry 4.0 at the UPC.

05

EDUCATION

Degrees, masters, postgraduates and continuous training offered at the UPC and the UPC School in the field of industry 4.0.



01 THE UPC

The Universitat Politècnica de Catalunya (UPC) is a public institution of research and higher education in the fields of engineering, architecture, sciences and technology, and one of the leading technical universities in Europe.

The UPC participates in the innovation system of Catalonia with projects and contracts for research, development, valorization of knowledge and commercialization of technology.



UNIVERSITAT POLITÈCNICA
DE CATALUNYA
BARCELONATECH

RESEARCH, DEVELOPMENT AND INNOVATION ACTIVITY AT THE UPC IN 2022

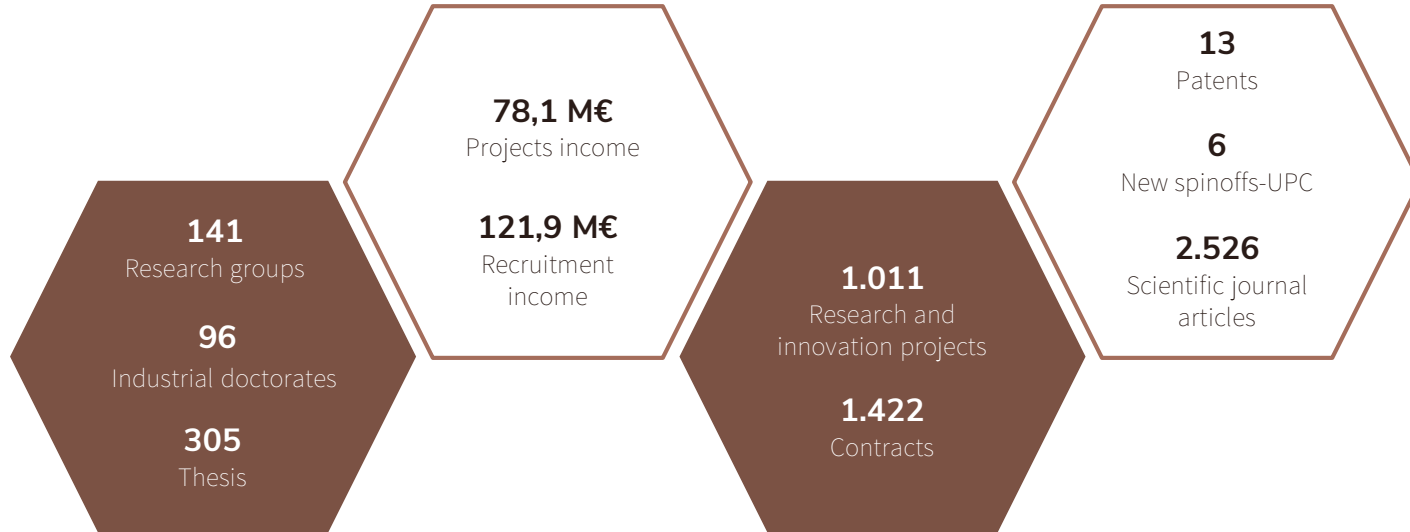

02

INDUSTRY 4.0

Industry 4.0 focuses its production on the cyber-physical transformation of manufacturing processes, systems and methods, and on its autonomous and decentralized operation, coordinated at the same time with commercial and logistics systems.



This new way of managing production expresses the idea that the industrial world is in the so-called fourth industrial revolution.

This is mainly characterized by the interconnection between machines and technology, the integration of human operators with the production environment, as well as the fluid exchange of information with the outside at the supply/demand level of both markets and customers, generating smart factories.



TECHNOLOGICAL AREAS ON WHICH INDUSTRY 4.0 IS BASED

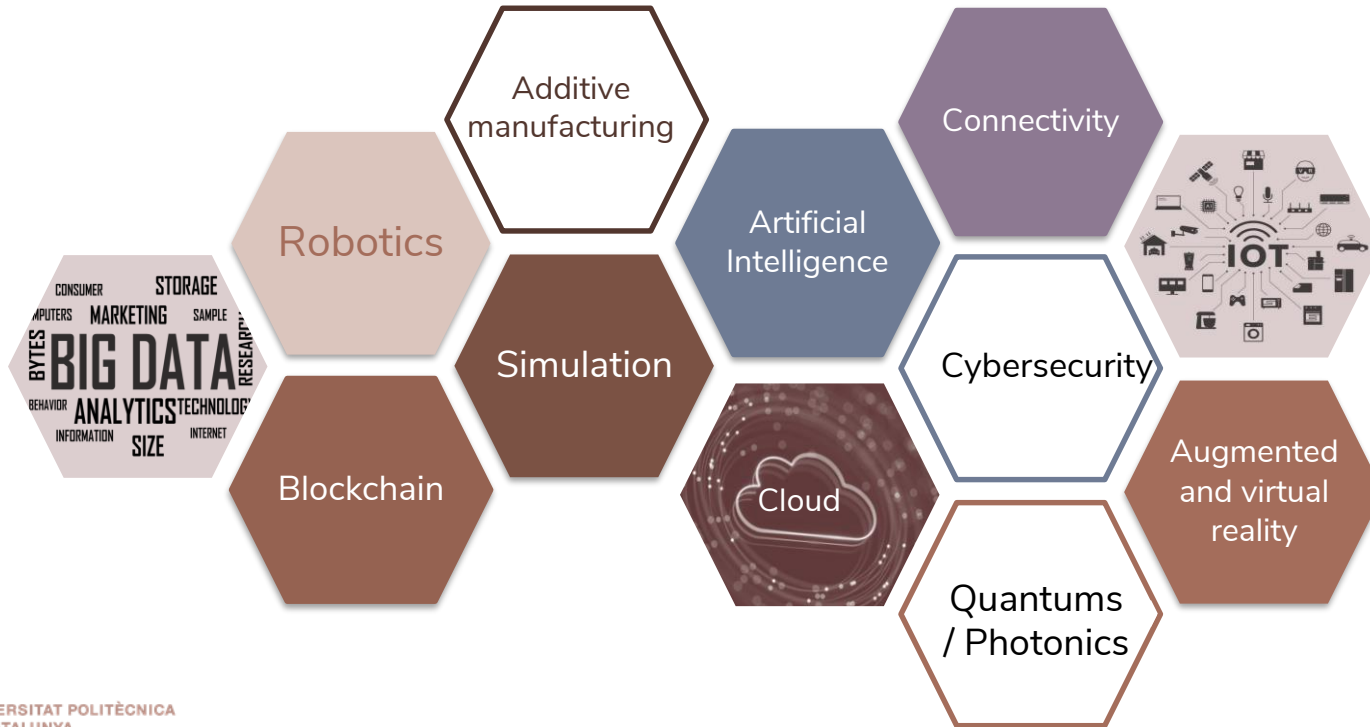

INDUSTRY 4.0

All these digital tools, or 4.0 tools, are entering the value chain, transforming the main operations and business models, as well as providing solutions to the main demands found in today's industry. The main trends they focus on are design, with the person at the center, intelligent automation, 100% remote control capability, and sustainability.

The introduction of digital technologies will reshape factory operations and production, as well as the supply chain and customer contact.



**Digital
information**



**Smart
manufacturing**



**Automated
companies**



**Customer
connected**



INDUSTRY 4.0 VALUE CHAIN

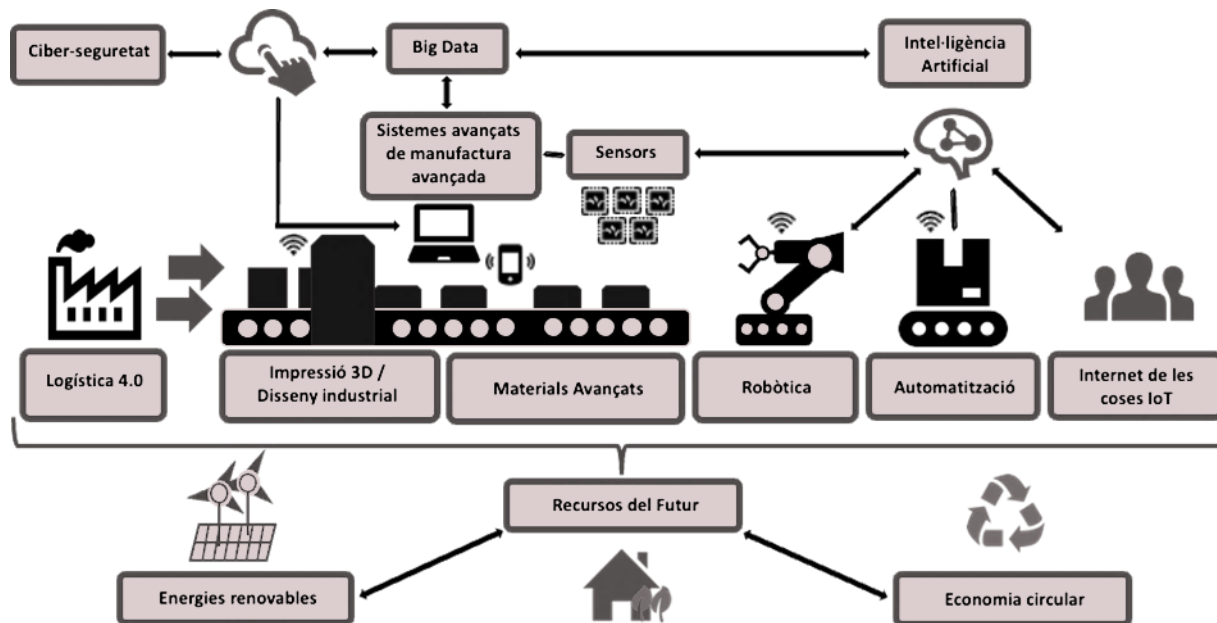

Examples of activity I

Promotion of interdisciplinary research in the field of Industry 4.0 based on the complementarity of the groups and the resulting increase in critical mass.

Evolution towards self-managed networks and services with the **5G** of the future.

Development of a platform for the management and monitoring of **cybersecurity vulnerabilities** in both the physical systems and the software involved in a company's IT infrastructure.

Development of **programming models** and **parallel execution** environments.

Experimental validation of substation connectors, sensorized, self-powered and capable of data transmission to the **cloud** and application of **big-data** techniques to facilitate **predictive maintenance**.

Implementation of collaborative robotics.

Fault detection in **multisensory systems**.



Examples of activity II

Development of new exploration techniques in open and closed environments with robots.

Use of **reinforcement learning algorithms** in planning problems.

Research, design and development, industrial testing of devices and **electronic circuits** for detection and measurement of **electric fields**.

Creation of **Digital Twins** of processes, production lines, factories and supply chains.

Improvement of **protection techniques against attacks and threats** in operating systems and networks, in the design and implementation of manufacturing tools or production plants in manufacturing automation processes.

Design of accelerators based on RISC-V technology, with the purpose of developing the new generation of computers.

Development of a digital course on **Artificial Intelligence** for workers and citizens in general.



03

RESEARCH & INNOVATION



UNIVERSITAT POLITÈCNICA
DE CATALUNYA
BARCELONATECH



R&D

Through the research groups distributed by its Schools and Faculties, the UPC has facilities and resources to provide its own services, in the areas of diagnosis, advice, development, demonstration, training, promotion and support to industry, the public sector and civil society in the promotion and deployment of Industry 4.0.

INDUSTRY 4.0 UPC RESEARCH GROUPS AND SUBGROUPS FOR EACH SECTOR



ROBOTICS

CDEI, GRINS, KR, LARCA, VIS



ELECTRONICS AND SENSORS

CIRCUIT, GREO, GREP, CITCEA, MCIA



ARTIFICIAL INTELLIGENCE

CEPIMA, GREC, KEMLG, LARCA, VIS, VEU



INFORMATION AND AUTOMATION SYSTEMS

BAMPLA, CBA, CDEI, CTTC, GESSI, CIEFMA, GNOM, GOAPI, GPI, IMP, KEMLG, LARCA, LEAM, LOGPROS, SAC, SCOM, TECNOFAB, VIS, VEU, CITCEA, DAMA, INLAB-FIB, MCIA



SIGNAL AND TELECOMMUNICATIONS

ANTENNALAB, BAMPLA, CBA, CIRCUIT, GRM, KEMLG, LEAM, CITCEA



ADVANCED MANUFACTURING

CDEI, CEPIMA, CERTEC, CODALAB, CTTC, CIEFMA, TECNOLAB, LABSON, MCIA, IOC



NUMERICAL METHODS

ACES, BAMPLA, CBA, CERTEC, CODALAB, CTYTC, GESSI, GNOM, GREO, KEMLG, LARCA, LOGPROG, SAC, INLABFIB, MCIA



DATA MANAGEMENT

GESSI, LOGPROG, SAC, SCOM, DAMA, MCIA, IOC

[More information on UPC research groups](#)



UNIVERSITAT POLITÈCNICA
DE CATALUNYA
BARCELONATECH

SPECIFIC RESEARCH CENTERS UPC – INDUSTRY 4.0

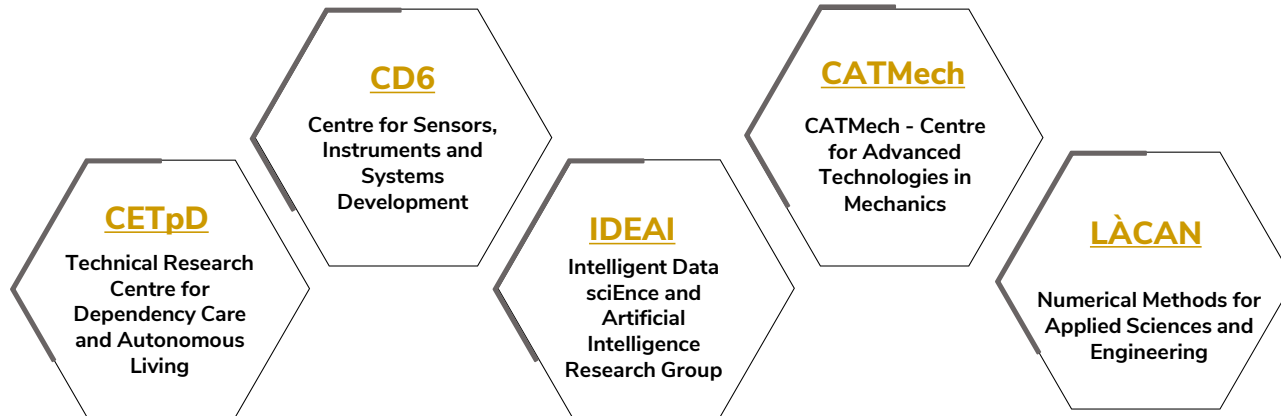

COLLABORATION AGREEMENTS WITH COMPANIES

ALSTOM

Applus[®]
IDIADA

ASCA
CENTRE TECNOLÒGIC



COMEXI

DANONE

dSPACE

EPSON

GIABAU
GROUP

Henkel



Iberpotash

LEAR
CORPORATION



OHL

Schneider
Electric

SEAT



SOLVAY

TMB



SPIN-OFFS

 **BEAMAGINE**

 **DATTIUM**
Industrial Data Analytics



**SMART
ENGINEERING**



rob surgical



NBYCOMP
NearbyComputing

MEDIATG



UNIVERSITAT POLITÈCNICA
DE CATALUNYA
BARCELONATECH

04

UPC EXCELLENCE PROJECTS

In this document are considered excellence projects those in which:

- The scientific process is rigorous and complex with high quality standards.
- They are strategic and tractors.
- They acquire a commitment to both social aspects and to great scientific and socioeconomic impact.
- They have repercussions on the territory.
- They comprise the different entities participating in the quadruple helix, so that the projects remain multidisciplinary.

The UPC excellence projects are financed by various programs, such as the State Plan or Horizon Europe.

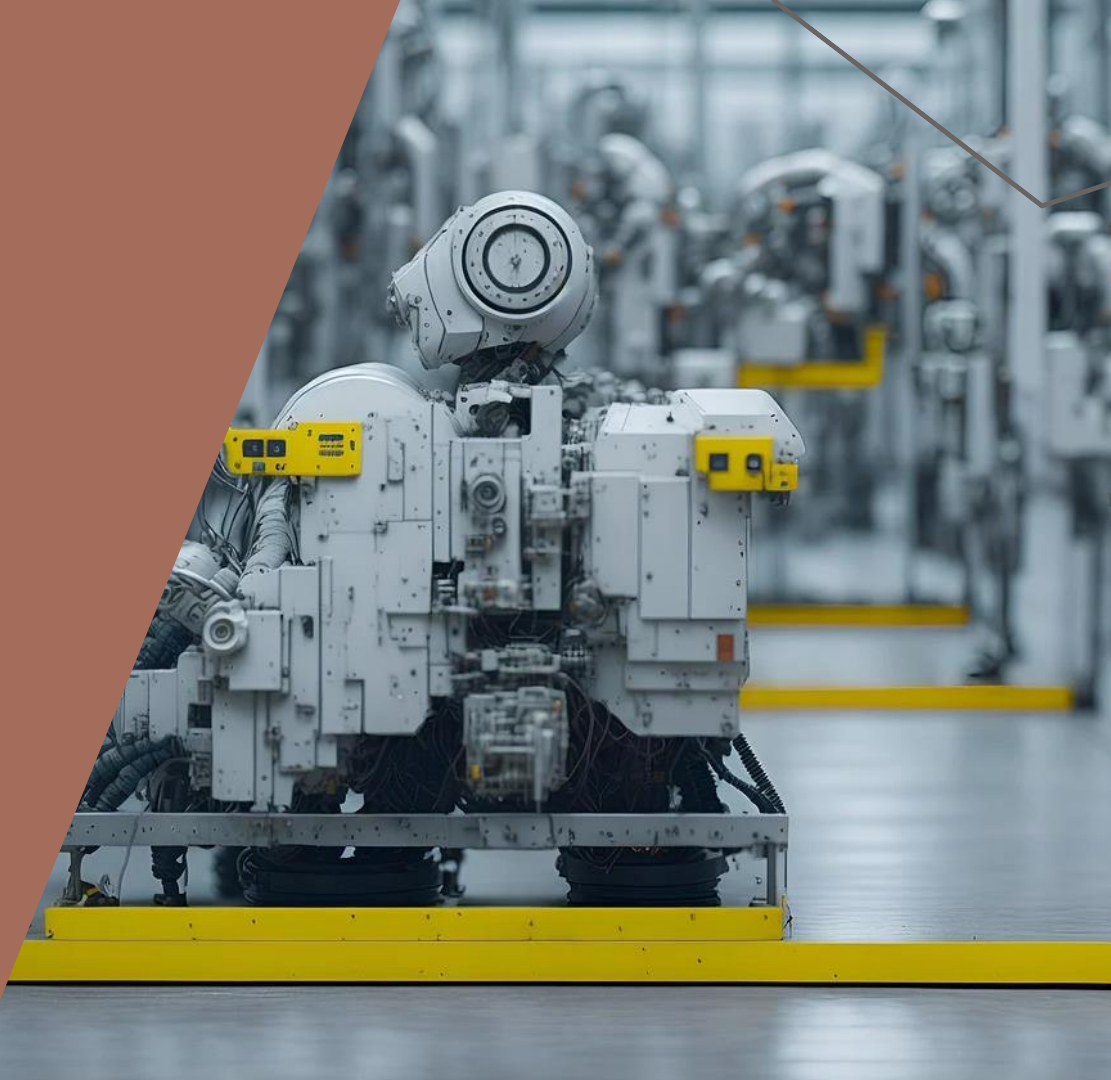

UPC EXCELLENCE PROJECTS

Agrupació Looming Factory

Looming factory aims to group, consolidate and guide the current research towards industrial demonstrators of verification and validation of current research results applicable to Industry 4.0.

The group collaborates around 4 sub-projects:

- **Smart Factory:** development of applications to make an efficient industry, with predictive operations and system monitoring.
- **Connected Factory:** preparation of technologies that manage the flow of telecommunications data, to make a connected industry.
- **Robots on Factory:** research on collaborative robots (arms and AGVs) and learning tools in a plant environment with the human-machine-robot relationship.
- **Factories of the Future:** demonstrative development of the other 3 projects.



UPC research groups involved: MCIA, BAMPLA, CDEI-DM, CETpD, CIRCUIT, CITCEA, CTTC, IDEAI, LEAM, SAC, VIS

UPC EXCELLENCE PROJECTS



XAFiR

LA XARXA D'INDÚSTRIA 4.0
DE CATALUNYA

Xarxa XaFIR - Xarxa Fourth Industrial Revolution

The XaFIR R+D+I Network brings together the most important players in research and development in the field of Industry 4.0 in Catalonia and aims to become a key disruptive agent in the transformation of Catalonia's industrial fabric, through the implementation mass of Industry 4.0 technologies in the productive sector of the territory, being at the same time a European benchmark for the fourth industrial revolution.

Therefore, the main purpose of the XaFIR Network is to promote and facilitate the transfer of knowledge in the form of products and services within the framework of Industry 4.0 to companies, especially SMEs.

UPC research group involved: MCIA



UNIVERSITAT POLITÈCNICA
DE CATALUNYA
BARCELONATECH

DIH4CAT – Catalonia Digital Innovation

The Catalonia Digital Innovation Hub is a regional innovation ecosystem, formed by the main agents supporting the digitization of Catalonia, with the aim of promoting the technological transformation of small and medium-sized companies, suppliers, technological startups and public entities.

The technological areas of DIH4CAT are arranged in different Digital Innovation Nodes (DIN) specialized in advanced technologies, which are mainly in the fields of Artificial Intelligence, Supercomputing, Cybersecurity, Smart Connectivity, 3D Printing, advanced manufacturing, robotics and photonics.



UPC EXCELLENCE PROJECTS

LATEM 4.0 - Multilevel materialization, digitalization and experimentation of structures by means of cyber physical systems of construction 4.0

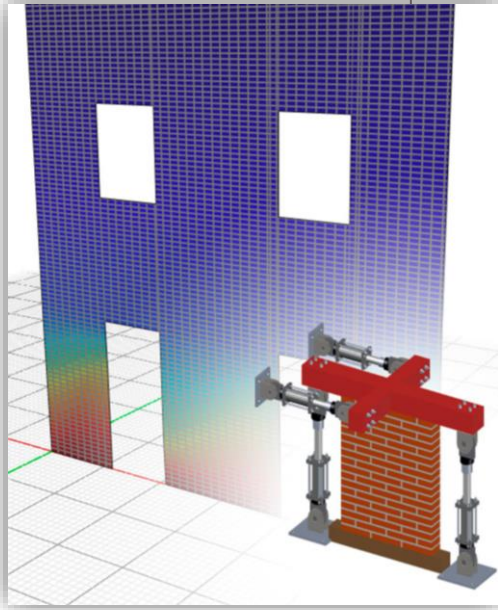

LATEM 4.0 combines physical tests with numerical computer simulation, allowing a complex structural system to be represented virtually, while carrying out the physical test of a structural element that composes it.

Thus, virtual models of complex structural systems (such as entire buildings, bridges or large infrastructures) will be integrated, in real time, with the physical experiment of critical subsystems (porticos, walls or elements). The physical response obtained in the laboratory can be digitized with high fidelity using the distributed fiber optic monitoring system.

The project will promote new lines of research and innovation in the construction sector, such as the development of digital twins of real structures, the study of the behavior of new materials and construction processes, the design of safer and more resilient infrastructures against natural risks and climate change and the promotion of sustainable construction.

UPC research group involved: Department of Civil and Environmental Engineering

UPC EXCELLENCE PROJECTS



TINTIN - A Tool for Incremental Data integrity checking

Given the importance of data today, it is surprising to realize that ensuring data quality is still a manual process, an error-prone task that takes a lot of time and increases the production costs of any software

This project aims to stop this major drawback of quality and efficiency in software development for all possible domains and proposes to build a tool that automatically guarantees the quality of the data, by effectively checking its adequacy to the required business rules .

To do this, it will build a commercial version of an existing research tool called TINTIN, which takes as input a series of business rules that the data must satisfy, currently written in the form of SQL statements.

UPC research groups involved: Department of Information Systems and Services Engineering

UPC EXCELLENCE PROJECTS

PIONER - Improved industrial production through energy optimization of production processes

The optimization and efficient use of data is a fundamental pillar of smart industry (or Industry 4.0) to achieve maximum adaptation to rapid market changes, containment of production costs and improved competitiveness.

The project will identify different possibilities for energy supply by analyzing different technologies that can be applied in existing facilities or in new facilities, including cogeneration. The aim is to optimize the operation of the process in order to maintain a high quality of the final product by minimizing costs and energy consumed.

UPC research group involved: CTTC



UPC EXCELLENCE PROJECTS

DOGO4ML - Development, Operation and Data Governance for ML-based Software Systems

The starting point of DOGO4ML is that the processes for developing, operating and governing MLSS must be better understood, refined, improved and operated, to support automation and lead to higher levels of efficiency and effectiveness .

DOGO4ML proposes an end-to-end holistic framework for developing, operating and governing MLSS and its data. This framework revolves around a new proposal called the DevDataOps lifecycle, which unifies two software lifecycles:

- The **DevOps cycle** aims to transform the requirements of an MLSS into deployed code (Dev) and get feedback as early as possible from end users (Ops) that can be used to evolve the requirements.
- The **DataOps cycle** provides support for the data management and analysis processes that characterize MLSS.

UPC research groups involved: Department of Information Systems and Services Engineering



UPC EXCELLENCE PROJECTS

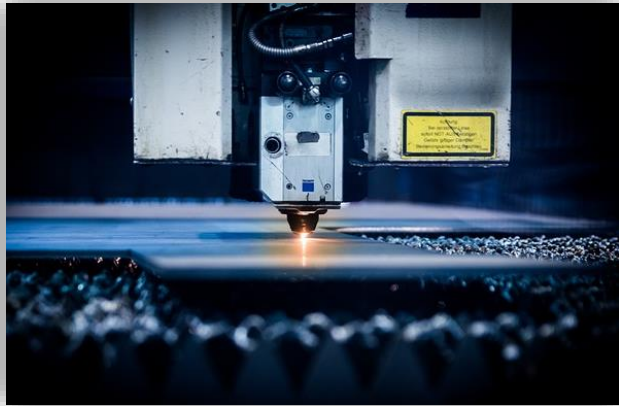

BIOMETAL - Development of a smart automated BIObased process for the recovery of valuable METALS from end-of-life phones

BINAFET builds a strategy for the integration of flows between buildings and Urban Agriculture (UA) as a key and necessary step for an ecological transition in cities.

The BINAFET project proposes a symbiotic interaction between buildings and urban agriculture, to improve their circularity by generating flows of residual heat, yellow water and CO₂ to reduce energy consumption, nutrient production, urban water pollution and increase local food production.

UPC research group involved: GRIC

A hand holding a paper airplane against a sunset background. The background is a blurred cityscape at dusk, with a hand in silhouette holding a white paper airplane. The scene is split by a diagonal line, with a white triangle on the left and a blurred sunset cityscape on the right.

05

EDUCATION



UNIVERSITAT POLITÈCNICA
DE CATALUNYA
BARCELONATECH

EDUCATION – BACHELOR'S DEGREES



[Bachelor's degree in ICT Systems Engineering](#)

[Bachelor's degree in Electronic Engineering and Telecommunications](#)

[Bachelor's degree in Electrical Engineering](#)

[Bachelor's degree in Industrial Electronics and Automatic Control Engineering](#)

[Bachelor's degree in Data Science and Engineering](#)

[Bachelor's degree in Telecommunications Systems](#)

[Bachelor's degree in Artificial Intelligence](#)

[More information on UPC bachelor's degrees](#) 

EDUCATION – MASTER'S DEGREES



[Erasmus Mundus Master in Big Data Management and Analytics \(BDMA\)](#)



[Master's degree in Automatic Systems and Industrial Electronics Engineering](#)



[Master's degree in Artificial Intelligence](#)

[Master's degree in Automatic Control and Robotics](#)



[Master's degree in Cybersecurity](#)

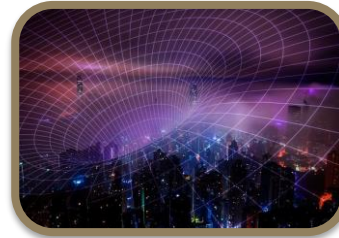

[Master's degree in Data Science](#)



EDUCATION – DOCTORAL PROGRAMMES

[Doctoral Programme in Automatic Control, Robotics and Vision](#)

[Doctoral Programme in Artificial Intelligence](#)

[Doctoral Programme in Signal Theory and Communications](#)

[Doctoral programme in Computing](#)

[Doctoral Programme in Electronic Engineering](#)

[Doctoral Programme in Electrical Engineering](#)

[Industrial Doctorates](#)



EDUCATION – MASTER'S OF UPC SCHOOL

MASTER'S DEGREE IN ADDITIVE MANUFACTURING

MASTER'S DEGREE IN BLOCKCHAIN TECHNOLOGIES

MASTER'S DEGREE IN ORGANIZATION AND ENGINEERING OF PRODUCTION AND MANAGEMENT OF INDUSTRIAL PLANTS (ENGIPLANT)

MASTER'S DEGREE IN SHIPPING BUSINESS

MASTER'S DEGREE IN SUPPLY CHAIN MANAGEMENT. OPERATIONS AND LOGISTICS

EDUCATION – POSTGRADUATES OF UPC SCHOOL

[POSTGRADUATE COURSE IN MATERIALIZATION OF MODELS AND TECHNOLOGIES IN INDUSTRY 4.0](#)

[POSTGRADUATE COURSE IN MODELING AND SIMULATION IN INDUSTRY 4.0](#)

[POSTGRADUATE COURSE IN ARTIFICIAL INTELLIGENCE WITH DEEP LEARNING](#)

[POSTGRADUATE COURSE IN FINTECH TECHNOLOGIES AND APPLICATIONS](#)

[POSTGRADUATE COURSE IN CLOUD COMPUTING ARCHITECTURE](#)

[POSTGRADUATE COURSE IN ORGANIZATION AND ENGINEERING OF PRODUCTION AND MANAGEMENT OF INDUSTRIAL PLANTS](#)

[More masters and postgraduates of continuing education at the UPC](#)





RESEARCH AND INNOVATION SUPPORT SERVICE

 <https://rdi.upc.edu>

 @RDI_UPC

 Recerca, Desenvolupament
i Innovació UPC



**UNIVERSITAT POLITÈCNICA
DE CATALUNYA
BARCELONATECH**